

**LEISTER**

PROCESS HEAT





**Accessories  
for industrial  
processes with  
Leister.**





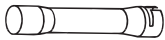
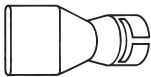

# Solve every problem with the right accessories from Leister.

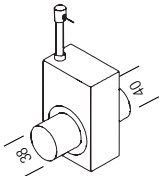
Some industrial hot air applications can be solved “off the peg” with a hot air device. But more often than not, the device has to be matched to the process. This takes place, on the one hand, through regulation and control of temperature and air flow. On the other hand, Leister offers an extensive accessories program. With nozzles and reflectors, the air stream can be concentrated to a point or expanded to fill a space. The accessory parts are proven in practice and are precisely matched to the respective hot air device.

## Accessories LHS Type 20S

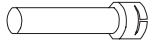
107.003		Deflecting nozzle 90°C, Ø 12 mm, push-fit
107.251		Extension tube 210 x 36.5 mm, push-fit
107.261		Wide slot nozzle 70 x 4 mm, push-fit
107.308		Sieve reflector 34 x 50 mm, push-fit
107.309		Sieve reflector 20 x 35 mm, push-fit
107.314		Sieve reflector 25 x 30 mm, push-fit
107.299		Air flow off/on switch The air flow is interrupted on command (pneumatic 5 bar) to the heaters. Size 214 x 88 x 133 mm



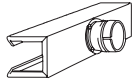
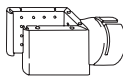
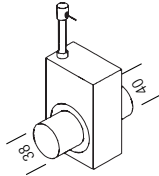

## Accessories LHS Type 40S and 40L

107.254		Flange connection, push-fit
107.255		Extension nozzle 36.5 x 160 mm, push-fit
107.256		Angled nozzle Ø 50 mm shank length 160 x 100 mm, push-fit
107.257		Tubular nozzle, length 600 mm Length of air outlet slot 420 mm, push-fit
107.258		Wide slot nozzle 70 x 10 mm, push-fit
107.270		Wide slot nozzle 150 x 12 mm, push-fit
107.331		Hinged reflector Ø 70 mm x B = 70 mm, push-fit
107.340		Shell reflector 45 x 250 mm, push-fit
107.327		Sieve reflector 85 x 85 mm, push-fit
107.330		Hinged reflector 125 x 22 mm, push-fit
107.299		Air flow off/on switch The air flow is interrupted on command (pneumatic 5 bar) to the heaters. Size 214 x 88 x 133 mm



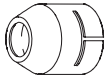
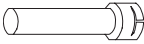

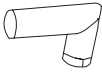
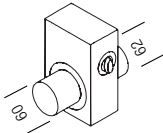
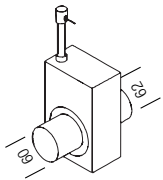

The accessory parts from the old Leister air heater generation also fit the LHS type devices:

LE 700	accessories	fits	LE MINI with nozzle adapter
LE 3000	accessories	fits	LHS 20S
LE 3300	accessories	fits	LHS 40S and 40L
LE 5000	accessories	fits	LHS 60S
LE 10000	accessories	fits	LHS 60L
ELECTRON	accessories	fit	MISTRAL

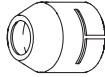

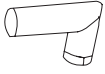
### Accessories LHS Type 60S

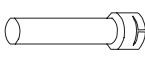
107.245		Round nozzle $\varnothing$ 40 mm, push-fit
107.247		Extension nozzle 200 x 40 mm, push-fit
107.253		Tubular nozzle, length 700 mm Length of air outlet slot 550 mm, push-fit
107.259		Wide slot nozzle 150 x 12, push-fit
107.260		Wide slot nozzle 85 x 15 mm, push-fit
107.262		Wide slot nozzle 300 x 4 mm, push-fit
107.265		Angled nozzle, shank length 120 x 112 mm, push-fit
107.295		Hand operated air flow adjuster and on/off switch. Air outlets and adaptors are standardised to allow all possible combinations. Size 133 x 88 x 133 mm
107.296		Air flow off/on switch The air flow is interrupted on command (pneumatic 5 bar) to the heaters. Size 214 x 88 x 133 mm

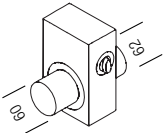
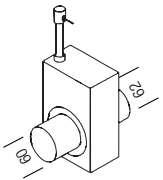

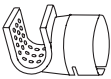
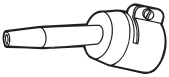
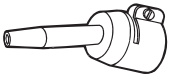

### Accessories LHS Type 60L

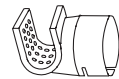
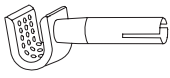
107.244		Round nozzle $\varnothing$ 50 mm, push-fit
107.267		Wide slot nozzle 500 x 15 mm, push-fit
107.268		Tubular nozzle, length 1200 mm Length of air outlet slot 1000 mm, push-fit
107.269		Angled nozzle, shank length 175 x 175 mm, push-fit
107.272		Wide slot nozzle 300 x 12 mm, push-fit
107.273		Extension nozzle 60 x 500 mm, push-fit
107.274		Wide slot nozzle 130 x 17 mm, push-fit
107.295		Hand operated air flow adjuster and on/off switch. Air outlets and adaptors are standardised to allow all possible combinations. Size 133 x 88 x 133 mm
107.296		Air flow off/on switch The air flow is interrupted on command (pneumatic 5 bar) to the heaters. Size 214 x 88 x 133 mm

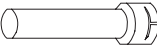

### Accessories LE MINI and LE MINI SENSOR

117.955		Nozzle adaptor, screw-on
107.311		Sieve reflector 50 × 35 mm for shrinking of sleeves and formed parts in PVC and PTFE, push-fit on adaptor
107.144		Round nozzle Ø 5 mm, push-fit on adaptor
107.145		Round nozzle Ø 10 mm, push-fit on adaptor
107.152		Round nozzle Ø 12 mm, for de-soldering IC's as well as shrinking of sleeves and moulded parts, push-fit on adaptor
107.310		Sieve reflector 20 × 35 mm for shrinking of sleeves and moulded parts in PVC and PTFE, push-fit on adaptor
107.324		Sieve reflector Ø 10 mm for soldering shrink solder connections and shrinking of PVC, PTFE, FEP sleeves. Push-fit on Ø 5 mm round nozzle





### Accessories LE 40000

107.230		Round nozzle Ø 100 mm, push-fit
107.231		Flange connector Ø 180 mm, push-fit on protection tube
107.232		Air intake connection, screw-on for Ø 60 mm air hose
107.233		Extension nozzle 400 × 100 mm, push-fit
107.235		Wide slot nozzle 500 × 15 mm, push-fit
107.243		Tubular nozzle, length 1500 mm Length of air outlet slot 1350 mm, push-fit

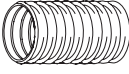

## Accessories KSR DIGITAL

106.956		Thermocouple with plug, 1 m cable
106.957		1 m thermocouple extension cable with plug and connection
106.958		2 m thermocouple extension cable with plug and connection
106.959		3 m thermocouple extension cable with plug and connection
106.960		4 m thermocouple extension cable with plug and connection
106.961		5 m thermocouple extension cable with plug and connection
106.962		10 m thermocouple extension cable with plug and connection

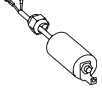
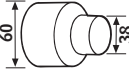
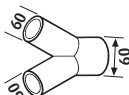
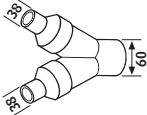
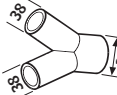

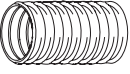

### Accessories to Medium Pressure Blower SILENCE

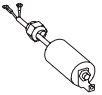
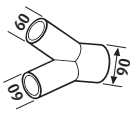
107.288		PVC air hose Ø 60 mm
107.287		Hose clip for Ø 60 mm air hose
107.240		Closing cap Ø 60 mm attachable to hose connection adaptor 107.238 and 107.278
107.294		Stainless steel filter, push-fit on air intake of SILENCE blower. Can be cleaned, for continuous operation
110.887		Motor capacitor 230 V for SILENCE blower
107.291		Hose connection adaptor with 1 air outlet for Ø 38 mm hose. Push-fit on air outlet of the SILENCE blower
107.278		Hose connection adaptor with 2 air outlet for Ø 60 mm hose. Push-fit on air outlet of the SILENCE blower
107.292		Hose connection adaptor with 2 air outlets for Ø 38 mm hose. Push-fit on air outlet of the SILENCE blower
107.293		Hose connection adaptor with 2 air outlet for Ø 38 mm hose. Push-fit on adaptor 107.292



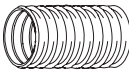

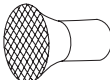
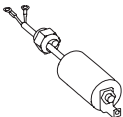
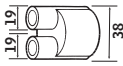
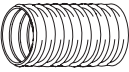
### Accessories to Medium Pressure Blower ASO

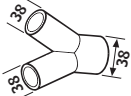
107.237		PVC air hose Ø 90 mm
107.236		Hose clip for Ø 90 mm air hose
107.239		Stainless steel filter, push-fit on the air intake of the ASO blower. Can be cleaned, for continuous operation
111.771		Motor capacitor 230 V for ASO blower
107.238		Hose connection adaptor with 2 air outlet for Ø 60 mm hose. Push-fit on air outlet of the ASO blower

### Accessories to High Pressure Blower ROBUST

107.350		PVC air hose $\varnothing$ 19 mm
107.290		Hose clip for $\varnothing$ 19 mm air hose
107.242		Closing cap $\varnothing$ 19 mm attachable to hose connection adaptor 107.298
107.354		Stainless steel filter push-fit on air intake of ROBUST blower
108.623		Motor capacitor 230 V for ROBUST blower
104.017		Motor capacitor 120 V for ROBUST blower
107.298		Hose connection adaptor, push-fit on ROBUST blower and adaptor 107.293 for hose connection
107.286		PVC air hose $\varnothing$ 38 mm
107.287		Hose clip for $\varnothing$ 38 mm and $\varnothing$ 60 mm air hose
107.241		Closing cap $\varnothing$ 38 mm push-fit on hose connection adaptors 107.292 and 107.293
107.293		Hose connection adaptor, push-fit on the ROBUST blower

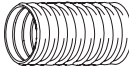

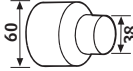
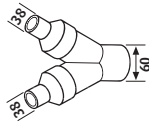
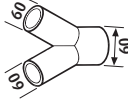





### Accessories to High Pressure Blower AIRPACK

107.287		Hose clip for $\varnothing$ 38 mm and $\varnothing$ 60 mm air hose
107.241		Closing cap $\varnothing$ 38 mm push-fit on hose connection adaptors 107.292 and 107.293
107.288		PVC air hose $\varnothing$ 60 mm
107.240		Closing cap $\varnothing$ 60 mm push-fit on hose connection adaptor 107.278
107.291		Hose connection adaptor with 1 air outlet for $\varnothing$ 38 mm hose. Push-fit on air outlet of the AIRPACK blower
107.292		Hose connection adaptor with 2 air outlets for $\varnothing$ 38 mm hose. Push-fit on air outlet of the AIRPACK blower
107.278		Hose connection adaptor with 2 air outlets for $\varnothing$ 60 mm hose. Push-fit on air outlet of the AIRPACK blower

### Accessories to Hot Air Blower MISTRAL

107.258		Wide slot nozzle 70 × 10 mm, push-fit
107.270		Wide slot nozzle 150 × 12 mm, push-fit
107.255		Extension nozzle 36.5 × 160 mm, push-fit
107.256		Angled nozzle Ø 50 mm shank length 160 × 100 mm, push-fit
107.257		Tubular nozzle, length 600 mm Length of air outlet slot 420 mm, push-fit
107.327		Sieve reflector 85 × 85 mm, push-fit
107.328		Hinged reflector 60 × 75 mm, push-fit
107.330		Hinged reflector 125 × 22 mm, push-fit
107.331		Hinged reflector 72 × 70 mm, push-fit
107.333		Sieve reflector 150 × 130 mm, push-fit
107.340		Shell reflector 45 × 250 mm, push-fit

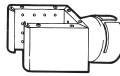
### Accessories to Hot Air Blower HOTWIND S

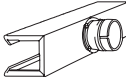
107.245		Round nozzle Ø 40 mm, push-fit
107.246		Flange connector, push-fit on protection tube
107.247		Extension nozzle 200 × 40 mm, push-fit
107.248		Stainless steel filter, push-fit, can be cleaned, for continuous operation
107.259		Wide slot nozzle 150 × 12 mm, push-fit
107.260		Wide slot nozzle 85 × 15 mm, push-fit
107.262		Wide slot nozzle 300 × 4 mm, push-fit
107.329		Sieve reflector Ø 75 mm, push-fit
107.336		Sieve reflector Ø 110 mm, push-fit
107.342		Shell reflector 400 × 50 mm, push-fit

## Accessories to Hot Air Blower VULCAN E

107.244		Round nozzle $\varnothing$ 50 mm, push-fit
107.267		Wide slot nozzle 500 x 15 mm, push-fit
107.272		Wide slot nozzle 300 x 12 mm, push-fit
107.273		Extension nozzle 500 x 60 mm, push-fit
107.274		Wide slot nozzle 130 x 17 mm, push-fit
107.275		Flange connector, push-fit on protection tube
107.277		Stainless steel filter, push-fit, can be cleaned, for continuous operation
107.341		Shell reflector 370 x 160 mm, push-fit

# All dimensions at a glance

On the following pages you will find the dimensions for the installation of all air heaters, blowers and hot air blowers featured in the Leister brochure "Industrial Processes with Hot Air".

## LHS CLASSIC 20S and 20L

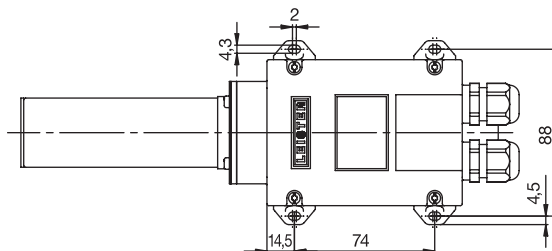
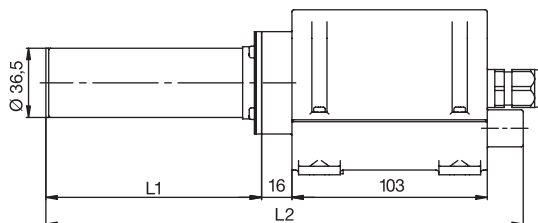
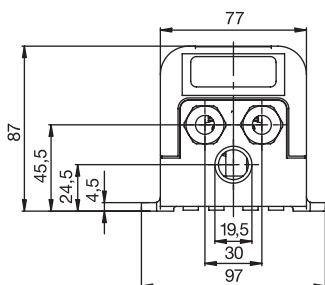

LHS 20S	L1 = 114 mm	L2 = 252 mm
LHS 20L	L1 = 144 mm	L2 = 282 mm

## LHS PREMIUM and SYSTEM 20S and 20L

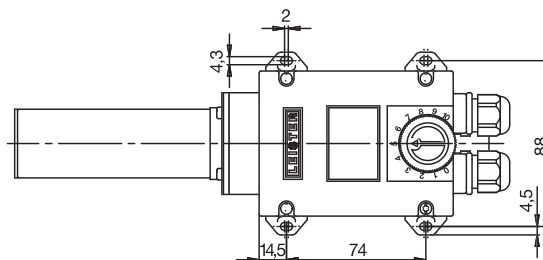
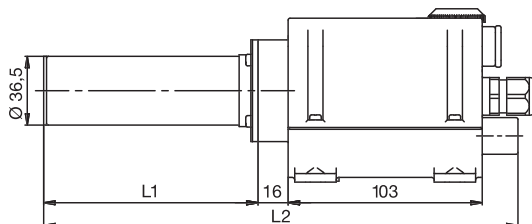
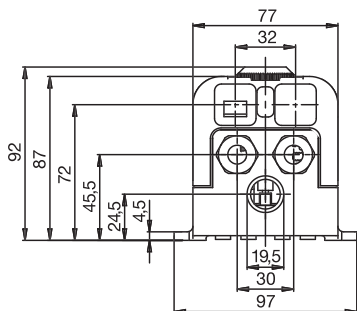

LHS 20S	L1 = 114 mm	L2 = 252 mm
LHS 20L	L1 = 144 mm	L2 = 282 mm

## LHS CLASSIC 40S and 40L

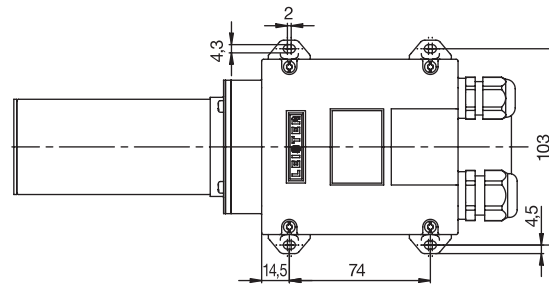
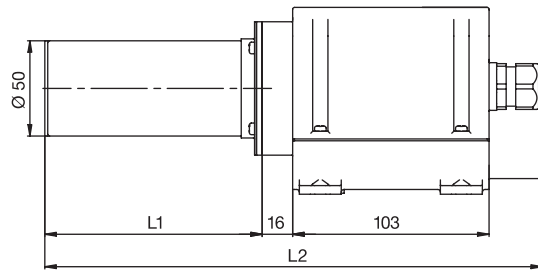
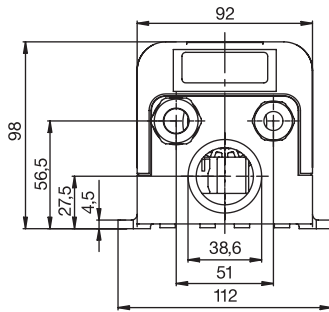

LHS 40S	L1 = 114 mm	L2 = 261 mm
LHS 40L	L1 = 144 mm	L2 = 291 mm

## LHS PREMIUM and SYSTEM 40S and 40L

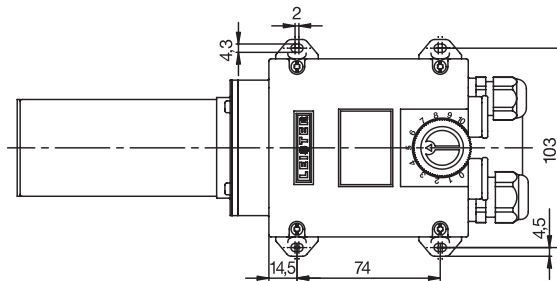
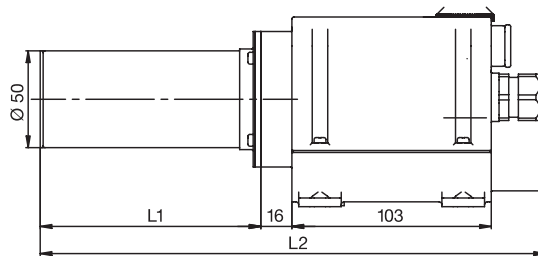
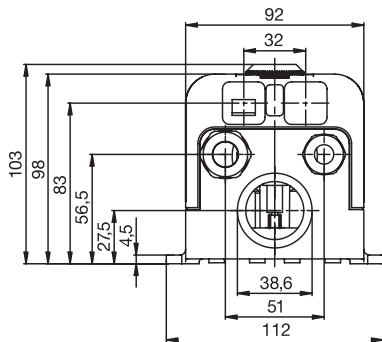

LHS 40S	L1 = 114 mm	L2 = 261 mm
LHS 40L	L1 = 144 mm	L2 = 291 mm

**LHS CLASSIC 60S and 60L**

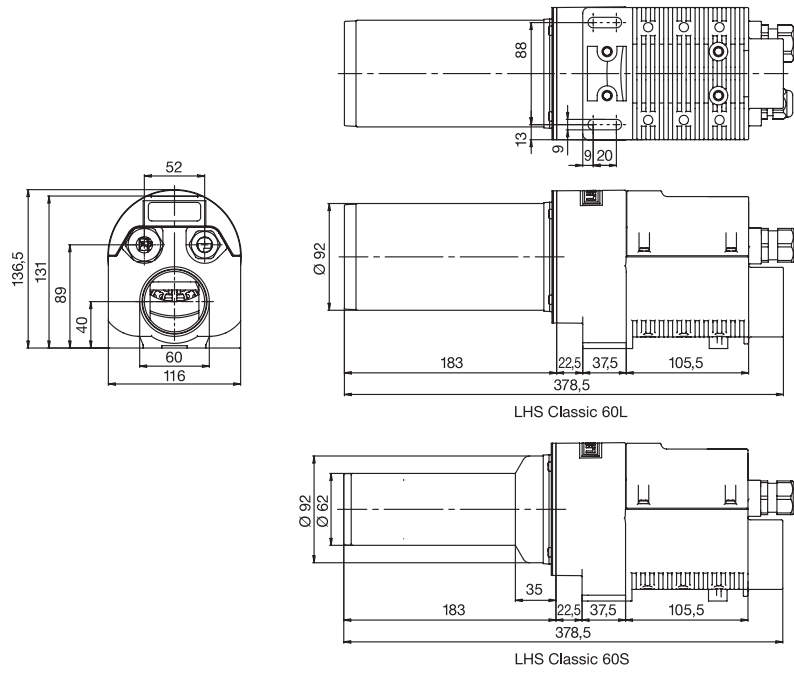

**LHS PREMIUM and SYSTEM 60S and 60L**

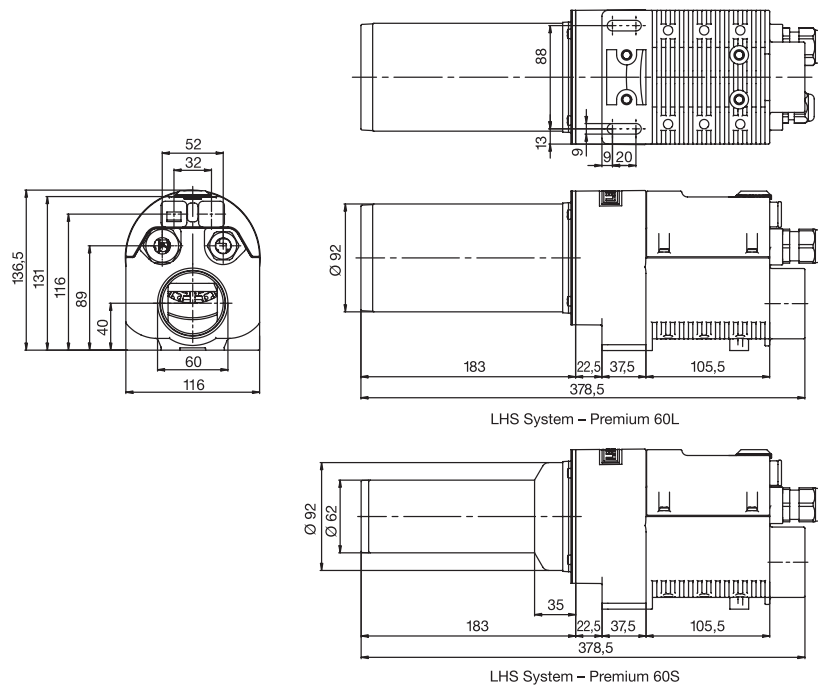

**LE MINI SENSOR and LE MINI**

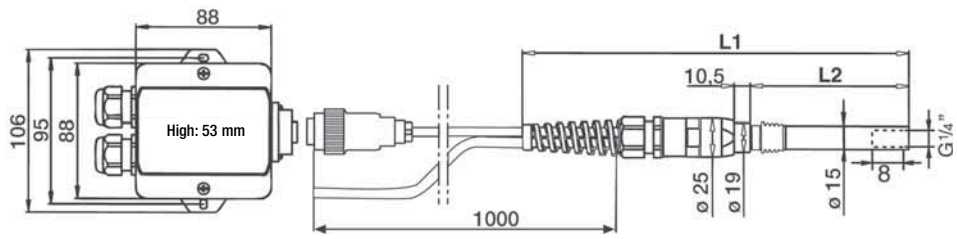

LE MINI SENSOR

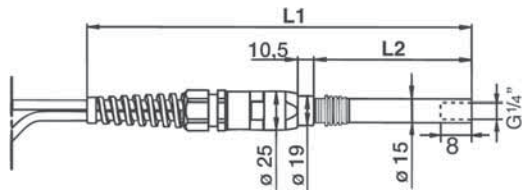

LE MINI

LE MINI 400	L1 = 253 mm	L2 = 104 mm
LE MINI 800	L1 = 308 mm	L2 = 159 mm

**LE 40000**

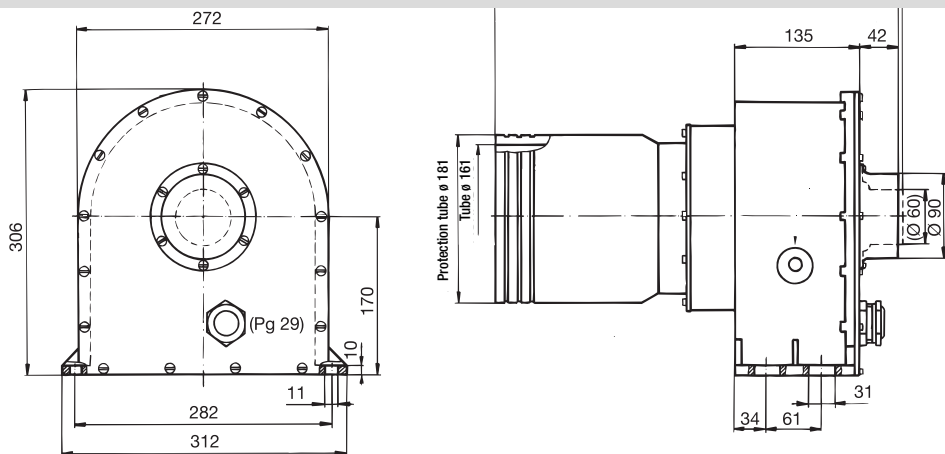

### Medium Pressure Blower SILENCE

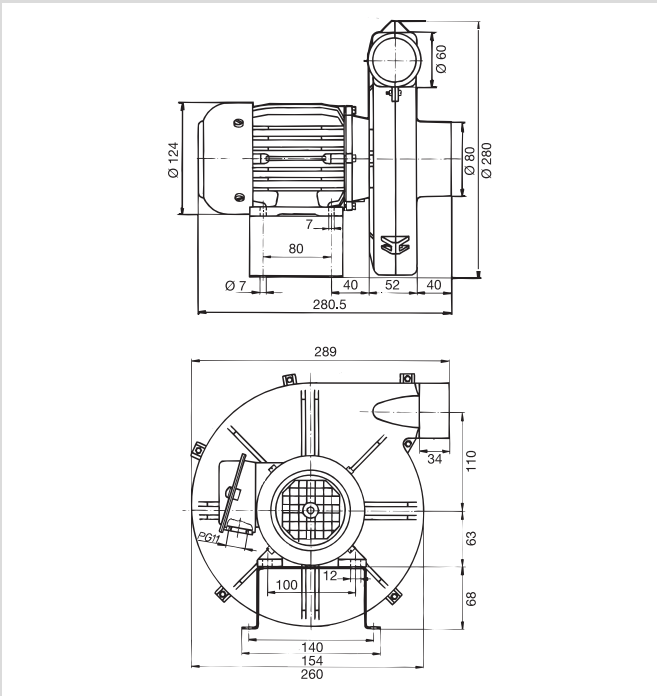

### Medium Pressure Blower ASO

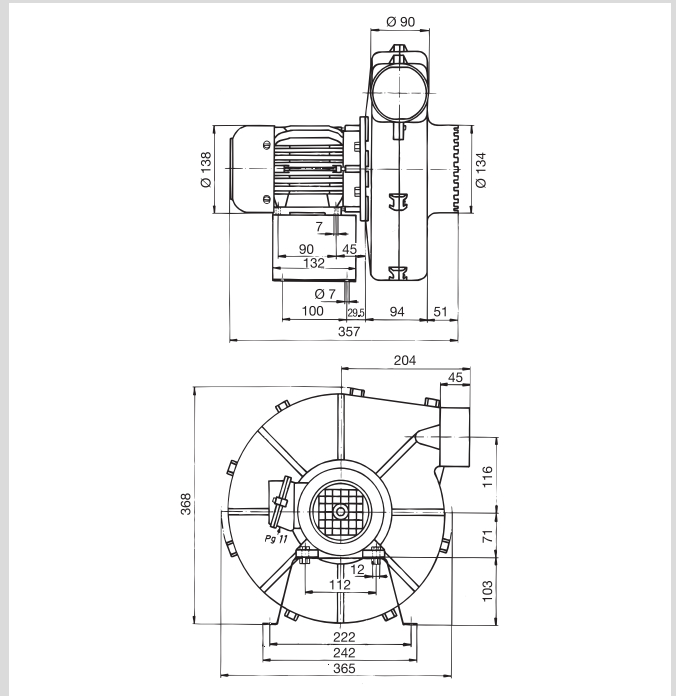

### High Pressure Blower ROBUST

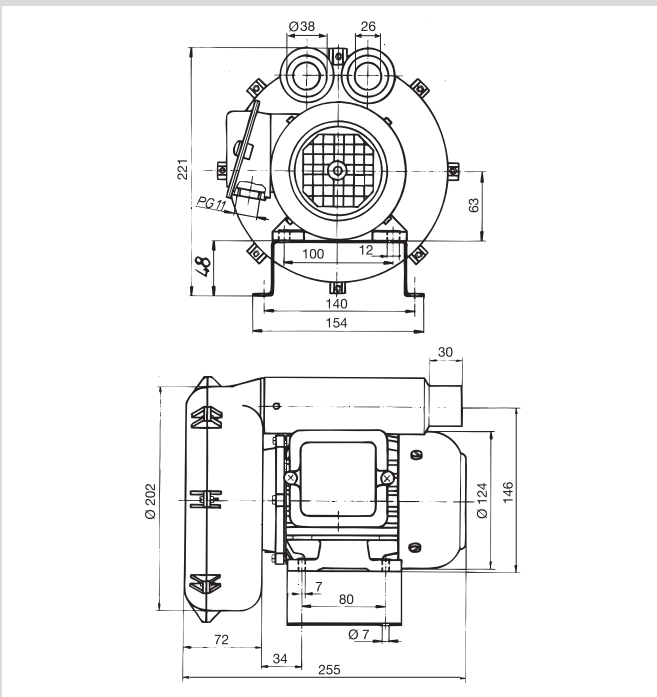

### High Pressure Blower AIRPACK

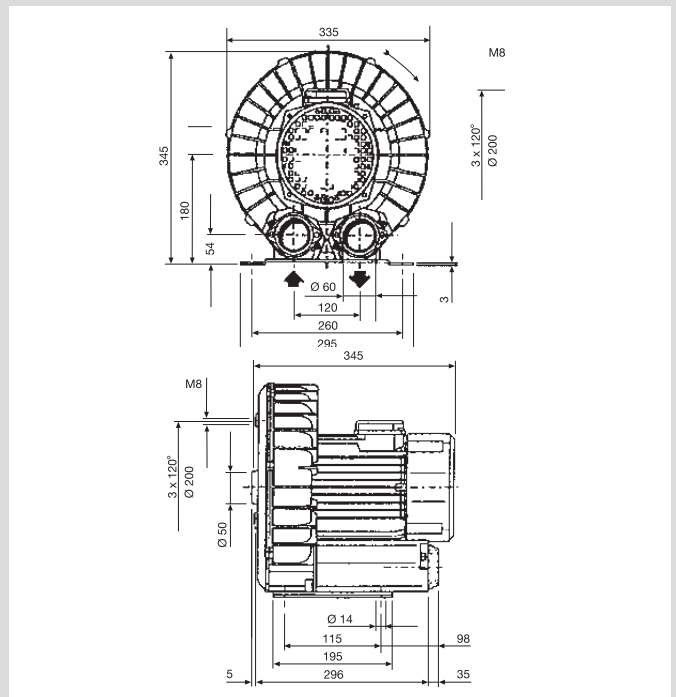

**Hot Air Blower MISTRAL**

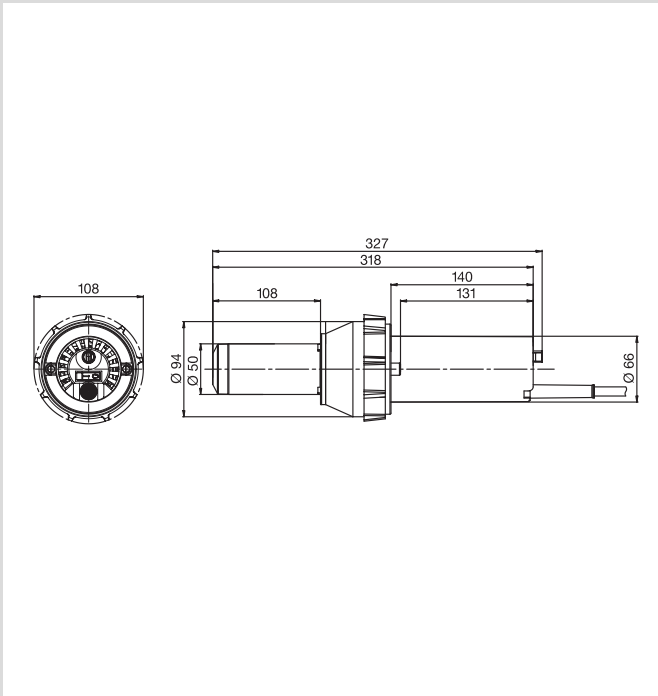

**Hot Air Blower HOTWIND S**

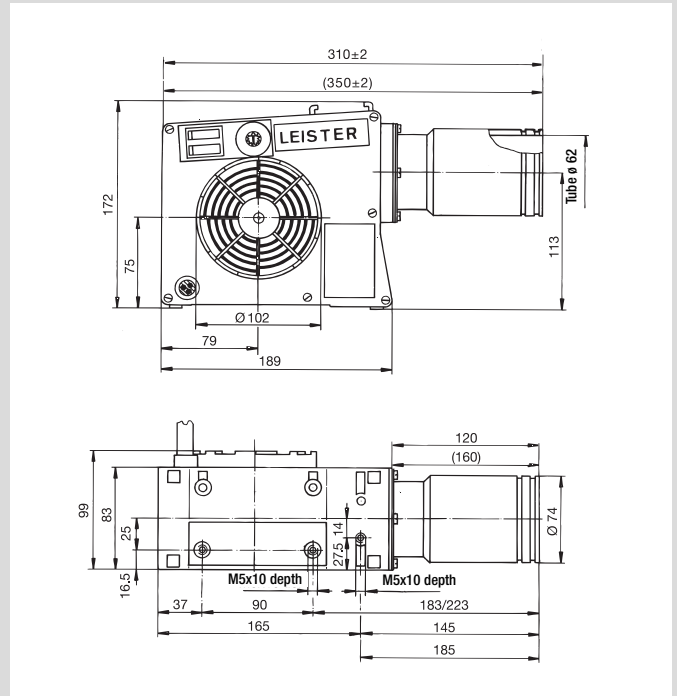

**Hot Air Blower VULCAN E**

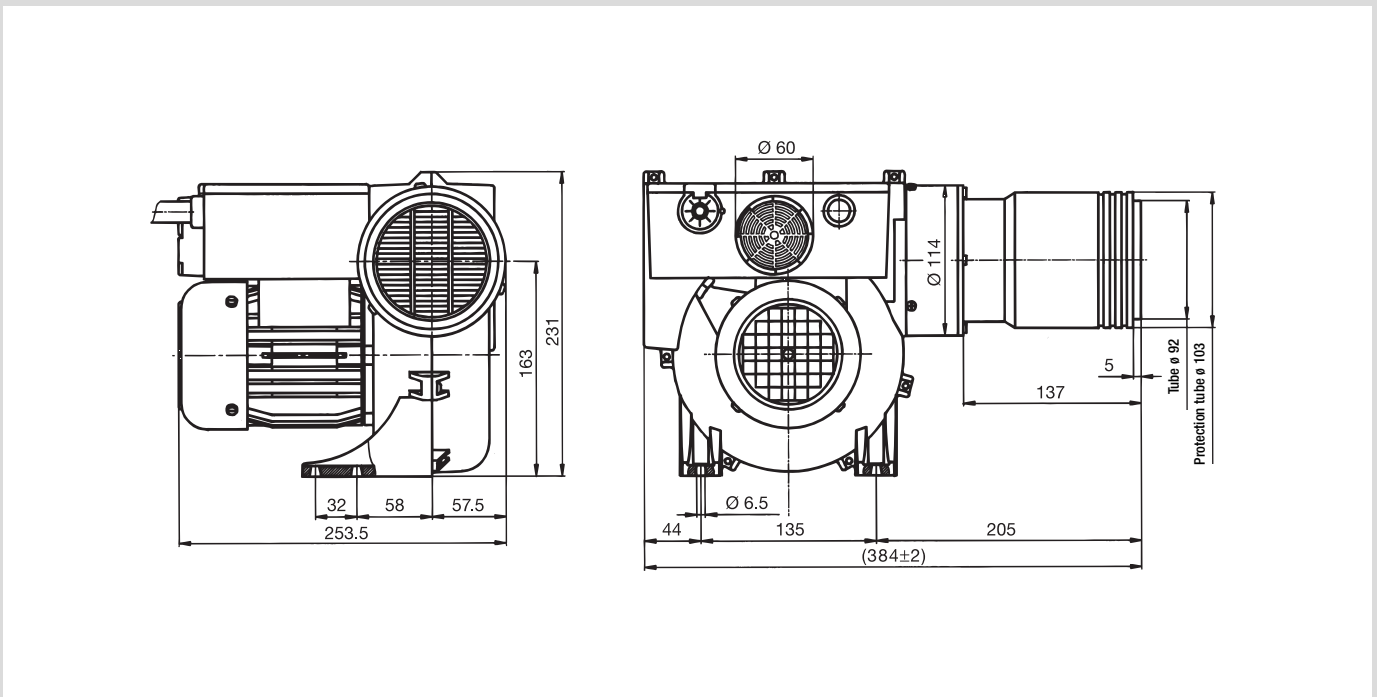



[www.leister.com](http://www.leister.com)

**Headquarter:**

Leister Process Technologies  
Riedstrasse  
6060 Sarnen/Switzerland  
phone: +41 41 662 74 74  
fax: +41 41 662 74 16  
[leister@leister.com](mailto:leister@leister.com)

**China:**

Leister Technologies Ltd.  
Building A, 1588 Zhuanxing Road  
Shanghai 201 108 PRC  
phone: +86 (21) 6442 2398  
fax: +86 (21) 6442 2338  
[leister@leister.cn](mailto:leister@leister.cn)